

Connector wire Specification

AS-FC-0009

AS-FC-0010

AS-FC-0011

AS-FC-0012

AS-FC-0013

AS-FC-0014

AS-FC-0015

AS-FC-0016

AS-FC-0017

AS-FC-0018

AS-FC-0019

AS-FC-0020

AS-FC-0021

AS-FC-0022

AS-FC-0023

AS-FC-0024

AS-FC-0025

AS-FC-0026























AS-FC-0027

AS-FC-0028

AS-FC-0029

AS-FC-0030

【Features】

Picture	Model	Material	Termination Points	Wire Size	Outer Diameter	Wire Length	Appearance Color	IP
	AS-FC-0009	Silicone	2PIN Male	18AWG(Red/Black)	φ6.0mm	250mm	White	IP68
	AS-FC-0010	Silicone	2PIN Male	18AWG(Red/Black)	φ6.0mm	500mm	White	IP68
	AS-FC-0011	Silicone	2PIN Male	18AWG(Red/Black)	φ6.0mm	2000mm	White	IP68
	AS-FC-0012	Silicone	2PIN Female	18AWG(Red/Black)	φ6.0mm	250mm	White	IP68
	AS-FC-0013	Silicone	2PIN Female	18AWG(Red/Black)	φ6.0mm	500mm	White	IP68
	AS-FC-0014	Silicone	2PIN Female	18AWG(Red/Black)	φ6.0mm	2000mm	White	IP68
	AS-FC-0015	Silicone	4PIN Male	20AWG (Red/Black/Green/Blue)	φ4.5mm	250mm	White	IP68
	AS-FC-0016	Silicone	4PIN Male	20AWG (Red/Black/Green/Blue)	φ4.5mm	500mm	White	IP68
	AS-FC-0017	Silicone	4PIN Male	20AWG (Red/Black/Green/Blue)	φ4.5mm	2000mm	White	IP68
	AS-FC-0018	Silicone	4PIN Female	20AWG (Red/Black/Green/Blue)	φ4.5mm	250mm	White	IP68
	AS-FC-0019	Silicone	4PIN Female	20AWG (Red/Black/Green/Blue)	φ4.5mm	500mm	White	IP68
	AS-FC-0020	Silicone	4PIN Female	20AWG (Red/Black/Green/Blue)	φ4.5mm	2000mm	White	IP68
	AS-FC-0021	Silicone	5PIN Male	20AWG(Red/Black) 22AWG(Green/Blue/White)	φ4.5mm	250mm	White	IP68
	AS-FC-0022	Silicone	5PIN Male	20AWG(Red/Black) 22AWG(Green/Blue/White)	φ4.5mm	500mm	White	IP68
	AS-FC-0023	Silicone	5PIN Male	20AWG(Red/Black) 22AWG(Green/Blue/White)	φ4.5mm	2000mm	White	IP68
	AS-FC-0024	Silicone	5PIN Female	20AWG(Red/Black) 22AWG(Green/Blue/White)	φ4.5mm	250mm	White	IP68
	AS-FC-0025	Silicone	5PIN Female	20AWG(Red/Black) 22AWG(Green/Blue/White)	φ4.5mm	500mm	White	IP68
	AS-FC-0026	Silicone	5PIN Female	20AWG(Red/Black) 22AWG(Green/Blue/White)	φ4.5mm	2000mm	White	IP68
	AS-FC-0027	Silicone	2PIN	18AWG(Red/Black)	φ6.0mm	150mm	White	IP68
	AS-FC-0028	Silicone	4PIN	20AWG (Red/Black/Green/Blue)	φ4.5mm	150mm	White	IP68
	AS-FC-0029	Silicone	5PIN	20AWG(Red/Black) 22AWG(Green/Blue/White)	φ4.5mm	150mm	White	IP68
	AS-FC-0030	Silicone	5PIN	20AWG(Red/Black) 22AWG(Green/Blue/White) Power wire:18AWG	φ4.5mm φ6.0mm	150mm	White	IP68

[Mechanical Parameter]

AS-FC-0009
AS-FC-0012

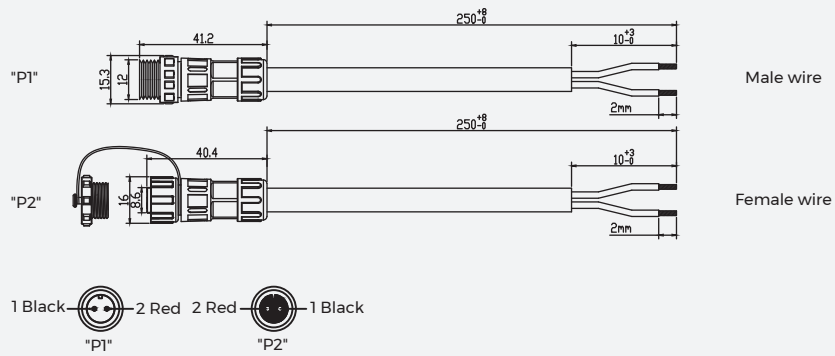

AS-FC-0010
AS-FC-0013

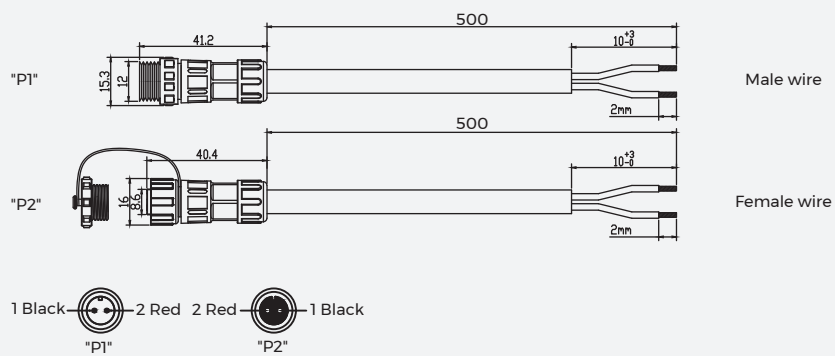

AS-FC-0011
AS-FC-0014

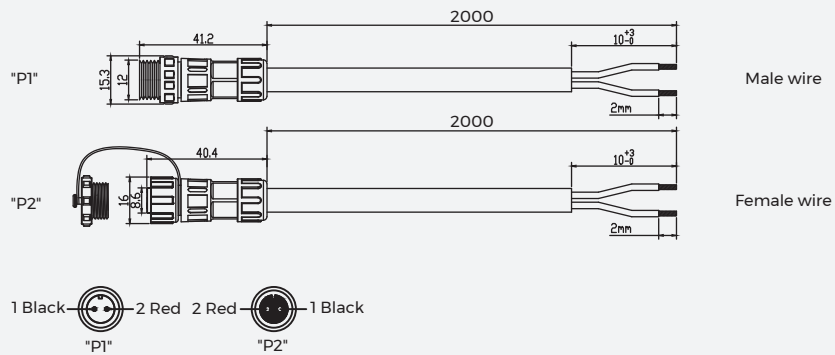

AS-FC-0015
AS-FC-0018

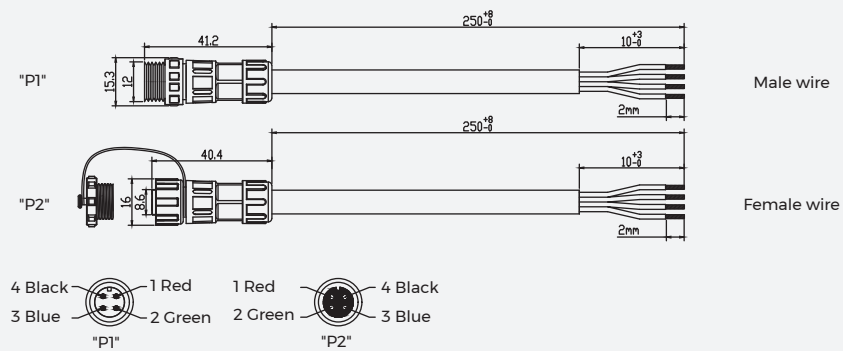

[Mechanical Parameter]

AS-FC-0016
AS-FC-0019

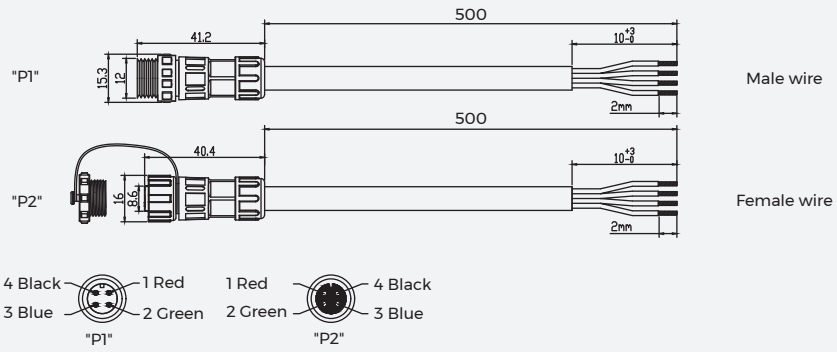

AS-FC-0017
AS-FC-0020

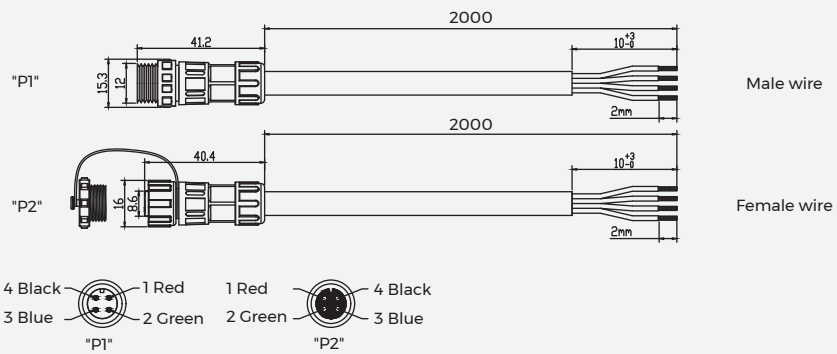

AS-FC-0021
AS-FC-0024

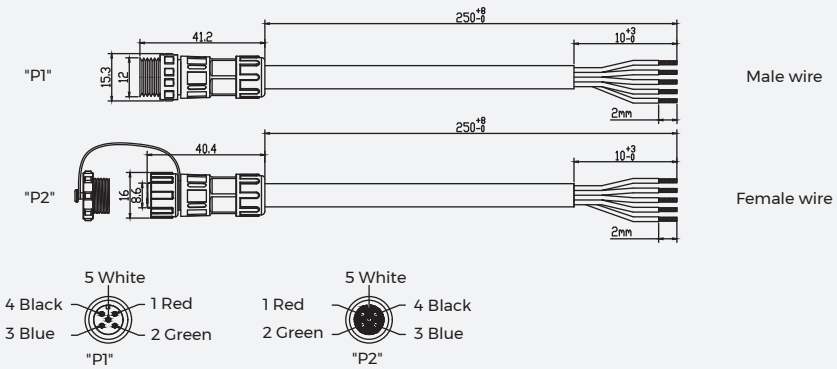

AS-FC-0022
AS-FC-0025

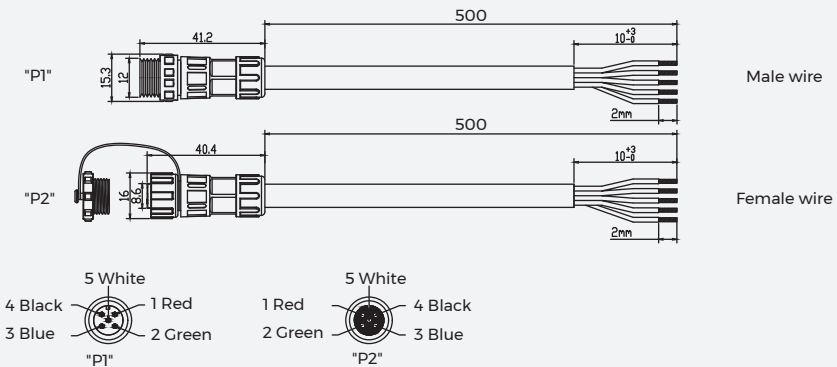

[Mechanical Parameter]

AS-FC-0023
AS-FC-0026

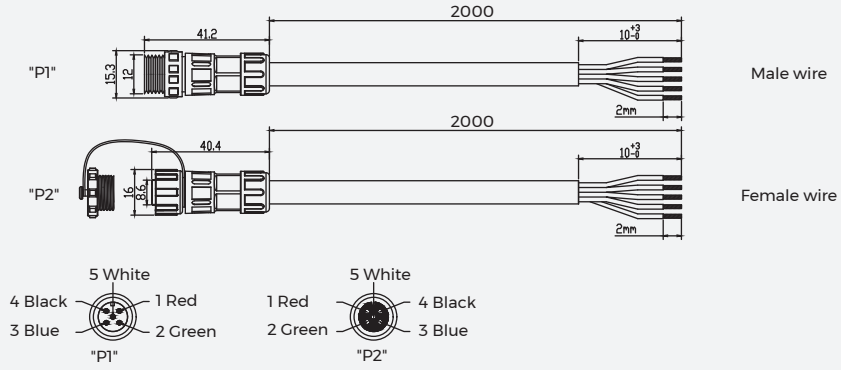

AS-FC-0027

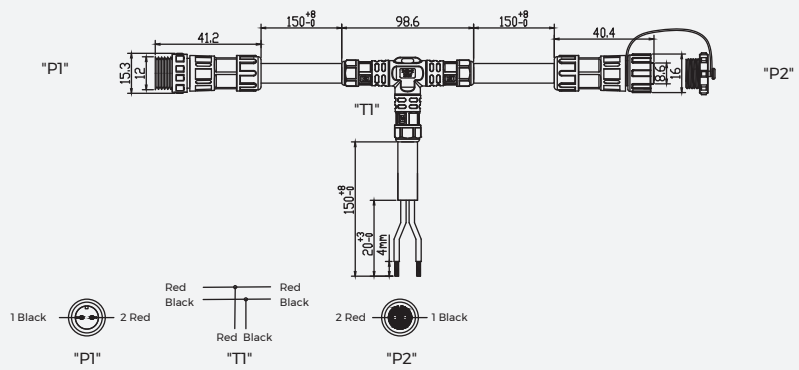

AS-FC-0028

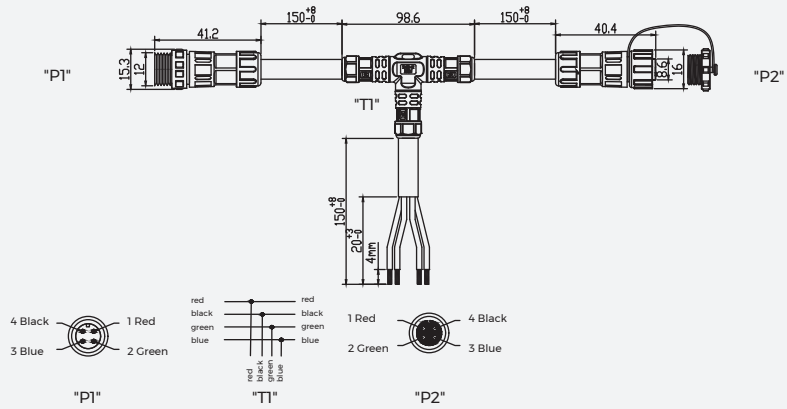

AS-FC-0029

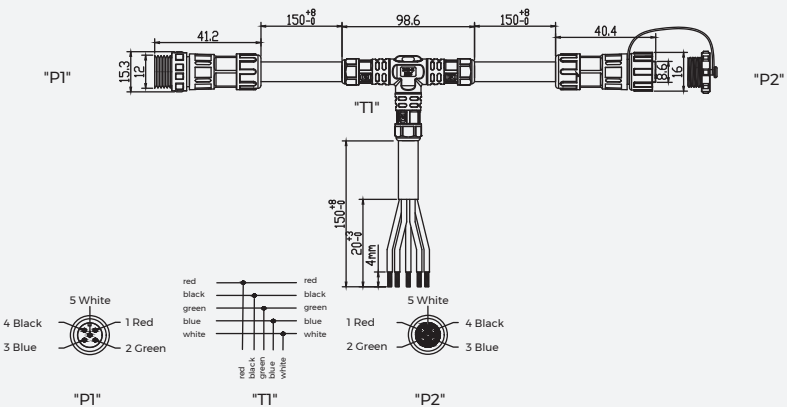

【Mechanical Parameter】



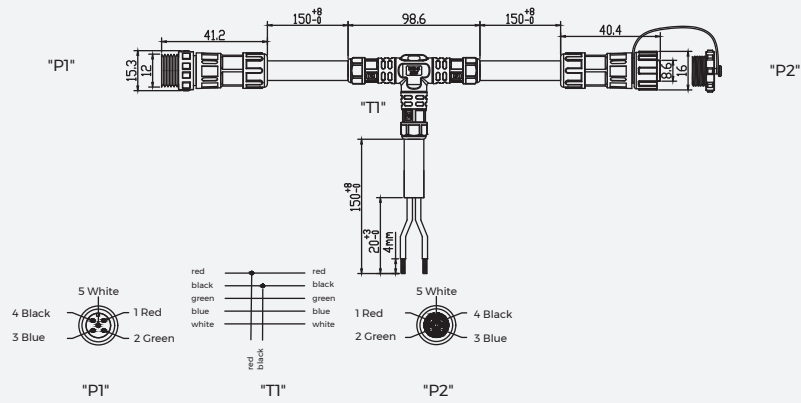







AS-FC-0030

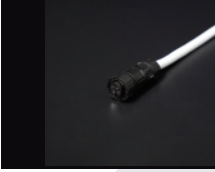



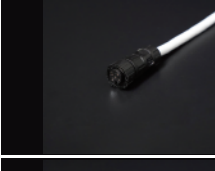

【Specification Information】

Description	Accessories Picture	Order model	Quantity/ case (PCS)	Net weight (kg)	Per box net weight (kg)	Gross weight (kg)	Packages (mm)	Compatible products
2PIN Male quick waterproof connector		AS-FC-0009	200	0.0193	3.86	4.16	250*250*150	Suitable for single color strip
2PIN Male quick waterproof connector		AS-FC-0010	200	0.031	6.2	6.5	250*250*150	Suitable for single color strip
2PIN Male quick waterproof connector		AS-FC-0011	50	0.1012	5.06	5.36	250*250*150	Suitable for single color strip
2PIN Female quick waterproof connector		AS-FC-0012	200	0.0212	4.24	4.54	250*250*150	Suitable for single color strip
2PIN Female quick waterproof connector		AS-FC-0013	200	0.0329	6.58	6.88	250*250*150	Suitable for single color strip
2PIN Female quick waterproof connector		AS-FC-0014	50	0.1031	5.16	5.48	250*250*150	Suitable for single color strip
4PIN Male quick waterproof connector		AS-FC-0015	200	0.0196	3.92	4.22	250*250*150	Suitable for RGB strip

[Specification Information]

Description	Accessories Picture	Order model	Quantity/ case (PCS)	Net weight (kg)	Per box net weight (kg)	Gross weight (kg)	Packages (mm)	Compatible products
4PIN Male quick waterproof connector		AS-FC-0016	200	0.0316	6.32	6.62	250*250*150	Suitable for RGB strip
4PIN Male quick waterproof connector		AS-FC-0017	50	0.1036	5.18	5.48	250*250*150	Suitable for RGB strip
4PIN Female quick waterproof connector		AS-FC-0018	200	0.0215	4.3	4.6	250*250*150	Suitable for RGB strip
4PIN Female quick waterproof connector		AS-FC-0019	200	0.0354	7.08	7.38	250*250*150	Suitable for RGB strip
4PIN Female quick waterproof connector		AS-FC-0020	50	0.1188	5.94	6.24	250*250*150	Suitable for RGB strip
5PIN Male quick waterproof connector		AS-FC-0021	200	0.0196	3.92	4.22	250*250*150	Suitable for RGBW/DMX strip
5PIN Male quick waterproof connector		AS-FC-0022	200	0.0316	6.32	6.62	250*250*150	Suitable for RGBW/DMX strip
5PIN Male quick waterproof connector		AS-FC-0023	50	0.1036	5.18	5.48	250*250*150	Suitable for RGBW/DMX strip
5PIN Female quick waterproof connector		AS-FC-0024	200	0.0215	4.3	4.6	250*250*150	Suitable for RGBW/DMX strip
5PIN Female quick waterproof connector		AS-FC-0025	200	0.0354	7.08	7.38	250*250*150	Suitable for RGBW/DMX strip

【Specification Information】

Description	Accessories Picture	Order model	Quantity/ case (PCS)	Net weight (kg)	Per box net weight (kg)	Gross weight (kg)	Packages (mm)	Compatible products
5PIN Female quick waterproof connector		AS-FC-0026	50	0.1188	5.94	6.24	250*250*150	Suitable for RGBW/DMX strip
2P T-Connection Wire		AS-FC-0027	20	0.065	1.31	1.6	250*250*150	suitable for single color strip Wire length 150mm
4P T-Connection Wire		AS-FC-0028	20	0.068	1.35	1.65	250*250*150	suitable for RGB led strip Wire length 150mm
5P T-Connection Wire		AS-FC-0029	20	0.069	1.39	1.69	250*250*150	suitable for RGBW led strip Wire length 150mm
5P T-Connection Wire		AS-FC-0030	20	0.0698	1.396	1.696	250*250*150	suitable for DMX led strip Wire length 150mm

【Precautions】

- Wiring must be done in a dry environment,tighten each threaded fastener.